

MBL line QR axles and bushings



QR axles and bushings

QR axles	3
QR axles for specific hub types	4
Mini QR axles and position locks in stainless steel	5
Bushings for QR axles	7

QR axles

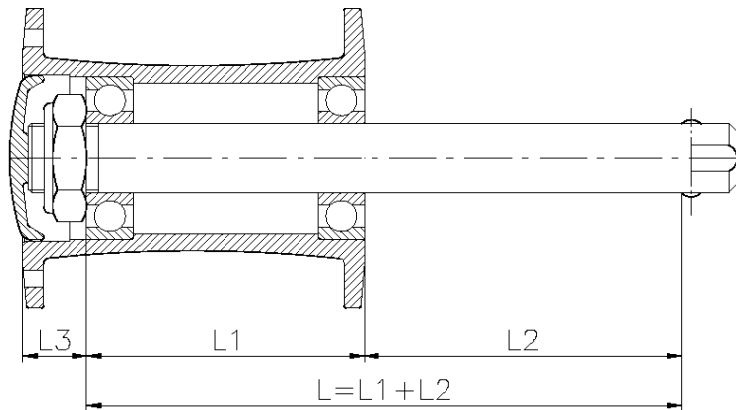

Find the right length!

- » The hub type determines the L3 distance and QR axle group.

QR axles with no cap on the pushbutton – suitable for all types of hubs

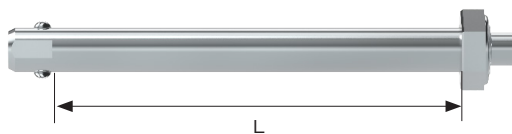

- » Hardened stainless steel
- » Axles are adjustable +/- 1 mm

 mm	Part. no. Ø12	Part. no. Ø1/2"
50	611011	-
85	611012	611105
98	611001	-
99	611004	611106
103	611006	-
104	611008	611101
108	611002	611103
112	-	611107
122	-	611102
123	611003	-

QR axles with tetra-grip for users with reduces hand strenght





- » Grip is made in black PA6 + GF

 mm	 mm	Part. no.
Ø12	98	6180T1
D12	103	6180T2
Ø 1/2"	99	6181T1
Ø 1/2"	104	6181T2

QR axles for specific hub types

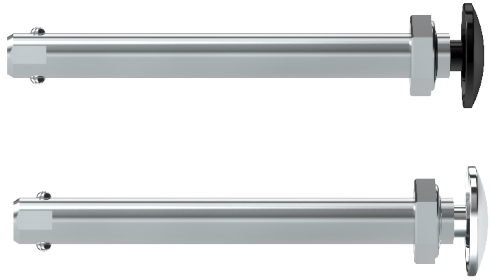
QR axles with aluminium push-button in black or silver for hub types: F1, F2, F3, F4, F5 and DF1 L3 distance for these hubs is 11 mm



 mm	 mm	Part no. with untreated push button	Part no. with black p.c. push button
Ø12	98	618202	618252
Ø12	103	618203	618253
Ø12	108	618204	618254
Ø12	109	618205	618255
Ø 1/2"	99	618302	618352
Ø 1/2"	104	618303	618353
Ø 1/2"	110	618305	618355

Sign up to our newsletter at mbl.dk to stay updated!





**QR axles with plastic push-button for hub types:
F1, F2, F3, F4, F5 and DF1 L3 distance for these hubs is 11 mm**

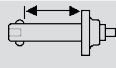

 mm	 mm	Part no. with plastic push-button
Ø12	98	618202D
Ø12	108	61820H
Ø 1/2"	123	on request

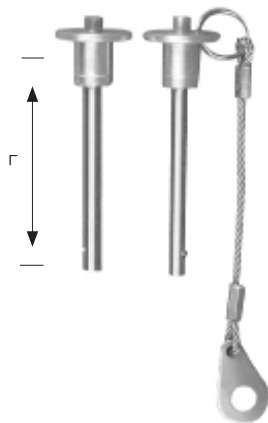
Mini QR axles and position locks in stainless steel

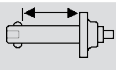

 mm	 mm	Part. no. with wire and ring	Part. no. without wire and ring
Ø1/4" (6,3 mm)	30	610607	610612
	35	610608	610613
	25	-	610817

» Other dimensions on request

Carbon solutions for rehab industry

**Skilfully engineered. Delivered fast.
Quality you can trust.**





View the video about
our carbon competencies.

Bushings for QR axes

- » Stainless steel
- » Available in many different lengths
- » Available in different outer diameters
- » Available with different hole diameters and tolerances



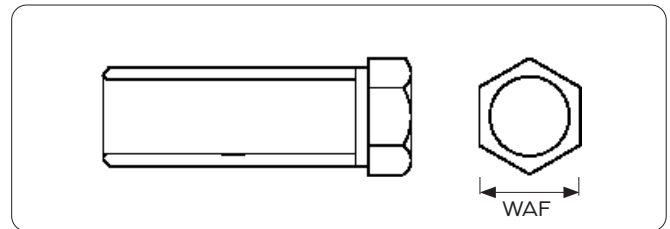

Type 1

 mm	 mm	Length mm	 g	WAF mm	Part. no.
M16 x 1	ø12	33/7	20	HEX 17	621036
M16 x 1	ø12	50/7	30	HEX 17	621011
M16 x 1	ø12	60/7	35	HEX 17	621012
M16 x 1	ø12	75/7	40	HEX 17	621013



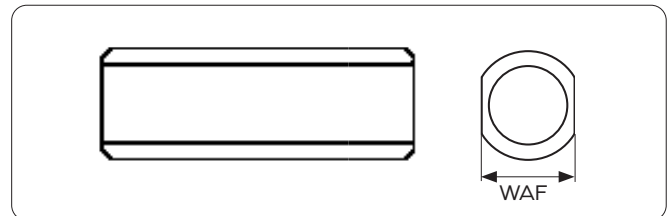

Type 2

 mm	 mm	Length mm	 g	WAF mm	Part. no.
M18 x 1.5	ø1/2"	51	35	16	621120
M18 x 1.5	ø1/2"	56	40	16	621119
M18 x 1.5	ø1/2"	69	50	16	621121



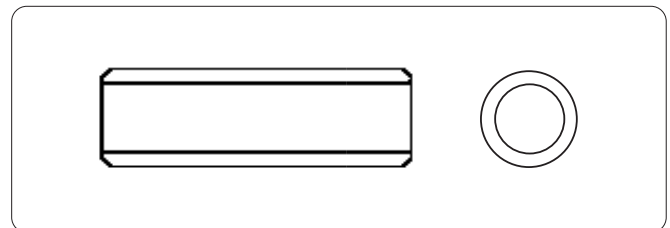

Type 3

 mm	 mm	Length mm	 g	WAF mm	Part. no.
M18 x 1	ø12	50	40	-	621022
M16 x 1	ø1/2"	51	25	-	621138
M18 x 1	ø1/2"	51	35	-	621139



Type 4

 mm	 mm	Length mm	 g	WAF mm	Part. no.
M16 x 1	ø1/2"	51/9-24,5	40	22	621116
M16 x 1	ø1/2"	51/9-22	35	20	621125
M16 x 1	ø1/2"	51/9-20	35	18	621126

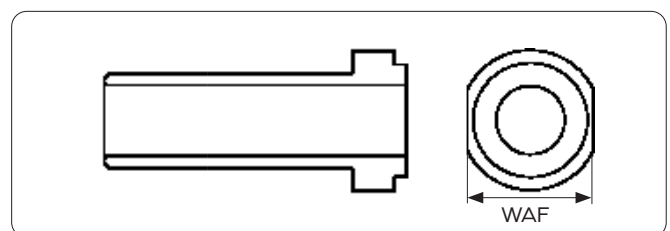

Would you like to see and learn more?

MBL website



Our videos on YouTube



Check our Facebook



Connect with us on LinkedIn



Connect with us on WeChat



Other product categories:

Front wheels 4"-8"



Rear wheels 12"-26"



Tyres, PU tyres, tubes , infills & tyres
w insert for manual wheelchairs 6"-26"



Pushrims & pushrim covers



Front forks & bearing housings



Hand brakes, brake handles & release handles



Other wheelchair components & accessories



Foam parts, supports & textiles



Tyres, tubes and tyres with infills
for power wheelchairs



MBL Denmark

MBL a/s

Glarmestervej 18 B, St. Th.

8600 Silkeborg

CVR: 12825242

contact@mbl.dk

MBL Poland

MBL Poland Sp. z o.o.

Sulejowska 45d

97-300 Piotrkow Trybunalski

VAT No: 7710008003

Tel: +48 44 73 24 100

contact@mbl.pl

MBL China

MBL (Xiamen) Co. Ltd.

No.289 Wengjiao Road Xinyang

Industrial District Haicang

361022 Xiamen

Tel: +86 592 5961 896

contact@mbl.com.cn

March 2026