

MBL line Hand brakes, brake handles & release handles

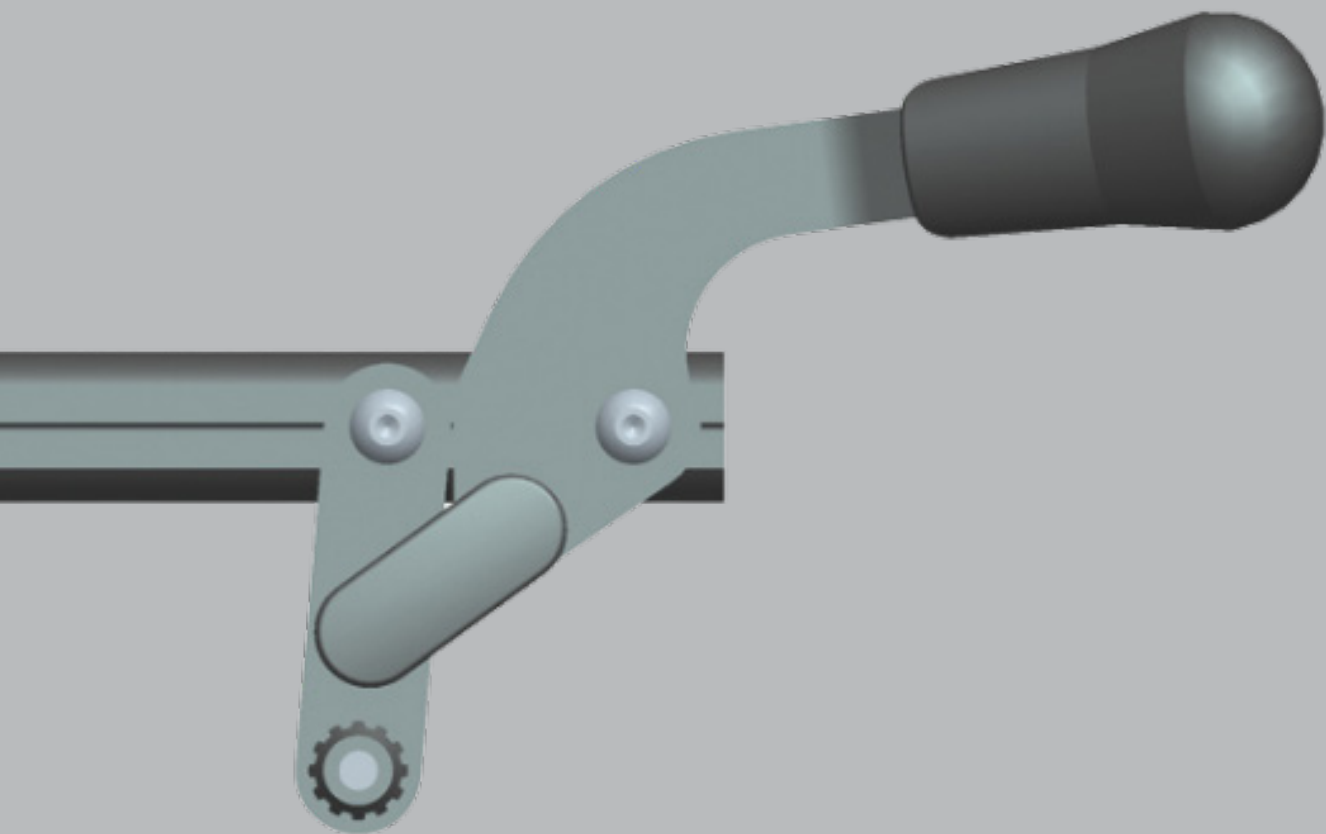

Hand brakes in aluminium

B1 – Brake with push to brake function and single bend brake lever

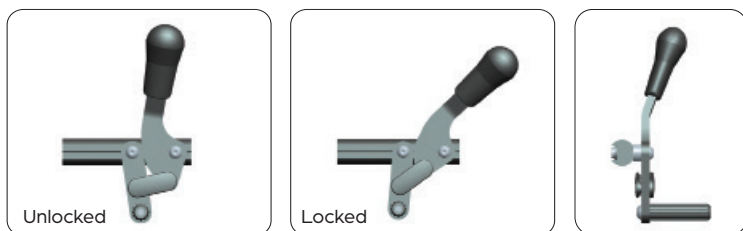

Description	Part. no. right	Part. no. left
Black	673061-R1	673062-L1

» Spring-loaded

B2 – Brake with push to brake function and double bend brake lever

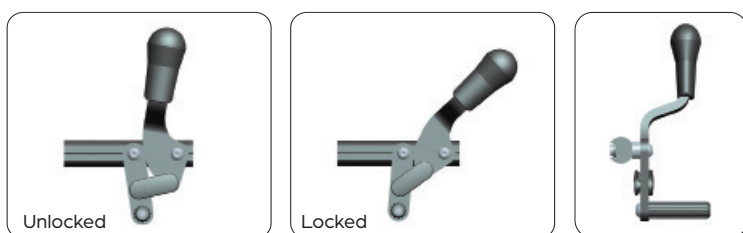

Description	Part. no. right	Part. no. left
Black	673063-R1	673064-L1

» Spring-loaded

B3 – Brake with push to brake function and single bend brake lever

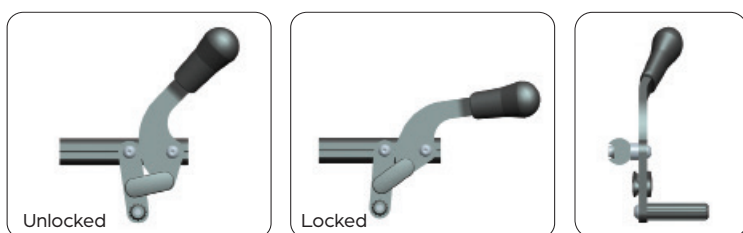

Description	Part. no. right	Part. no. left
Black	673065-R1	673066-L1

» Spring-loaded

B4 – Brake with push to brake function and double bend brake lever

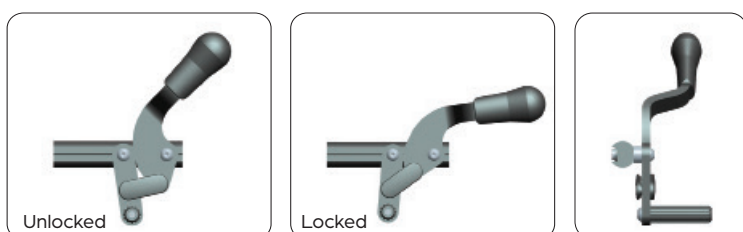

Description	Part. no. right	Part. no. left
Black	673067-R1	673068-L1

» Spring-loaded

B5 – Brake with pull to brake function and single bend brake lever

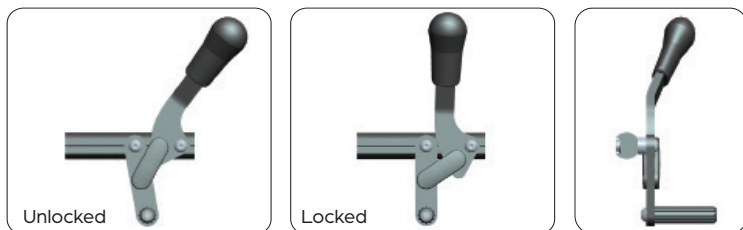

Description	Part. no. right	Part. no. left
Black	673069-R1	673070-L1

» Spring-loaded

B6 - Brake with pull to brake function and double bend brake lever

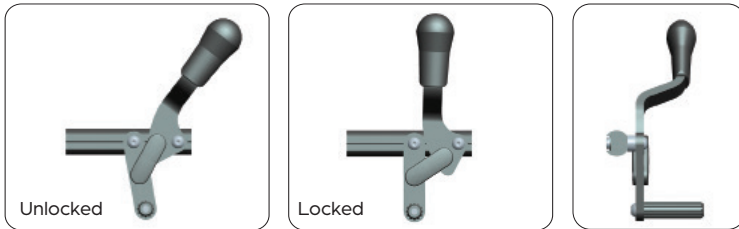

Description	Part. no. right	Part. no. left
Black	673071-R1	673072-L1

» Spring-loaded

B8 - Brake for people with limited strength with push to brake function and double bend brake lever

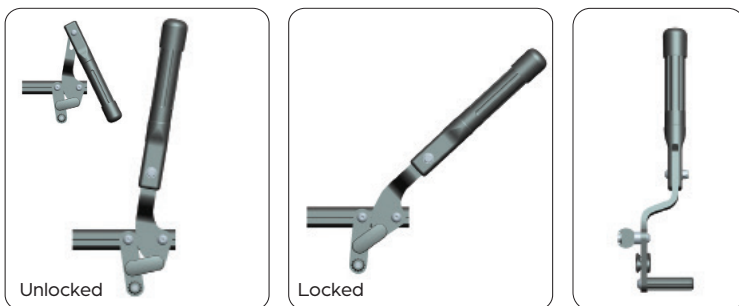

Description	Part. no. right	Part. no. left
Black	673075-R1	673076-L1

» Spring-loaded

Hand brakes in steel

B9 - Brake with push to brake function and single bend brake lever

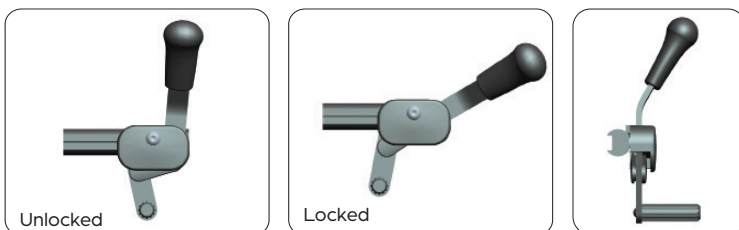

Description	Part. no. right	Part. no. left
Black	673077-R1	673078-L1

» Spring-loaded

B10 - Brake with push to brake function and double bend brake lever

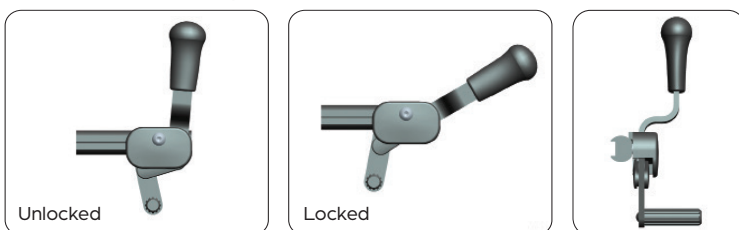

Description	Part. no. right	Part. no. left
Black	673079-R1	673080-L1

» Spring-loaded



Extension levers

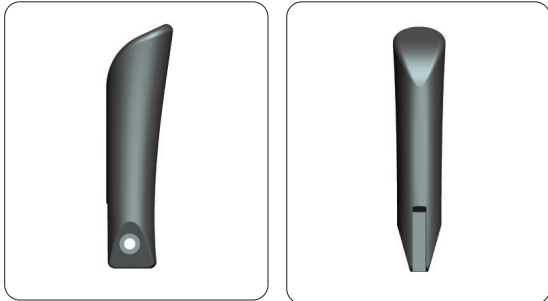

Extension levers for MBL hand brakes

- » Ergonomic shape
- » Foldable which gives easy transfer in and out of the chair
- » Reduce the needed brake force on the brake handle
- » Available in 2 different lengths
- » Available for brakes with both 4mm and 6mm lever.
- » Nice elegant design
- » Material: Black PA+GF

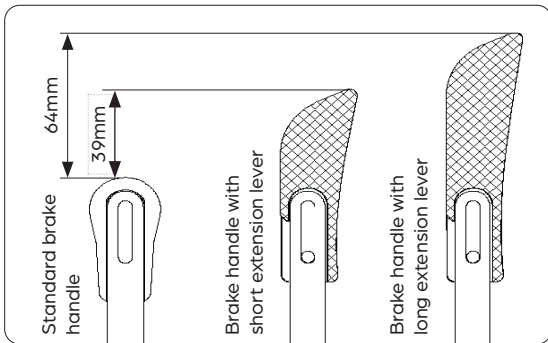

Description	Part. no. right side	Part. no. left side
Extension lever for alu brakes (Short)	673219	673216
Extension lever for alu brakes (Long)	67321A	673217
Extension lever for steel brakes (Long)	673218	673214

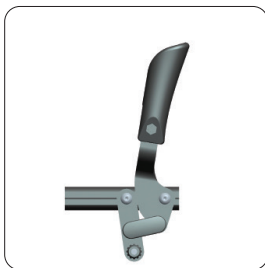

< Brake handle with short extension lever

Brake handle with long extension lever >



Mounting clamps



Mounting clamp – black aluminium

Description	Part. no. Black
Complete mounting clamp for fitting brake on tube - Ø19/Ø20 mm	674005
Complete mounting clamp for fitting brake on tube - Ø19/Ø22 mm	674004
Complete mounting clamp for fitting brake on tube - Ø19/Ø25 mm	674001
Complete mounting clamp for fitting brake on tube - Ø19/Ø30 mm	674003

Handles – intro

Self-locking parking brake function

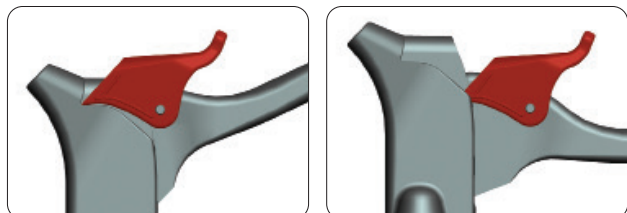

The stop lever pushes down automatically

Manual parking brake function

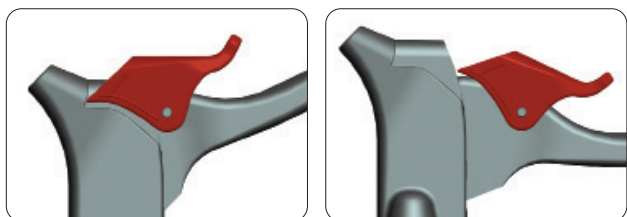

The stop lever pushes up - it has to be pushed down manually

Straight cable outlet vs. angled cable outlet

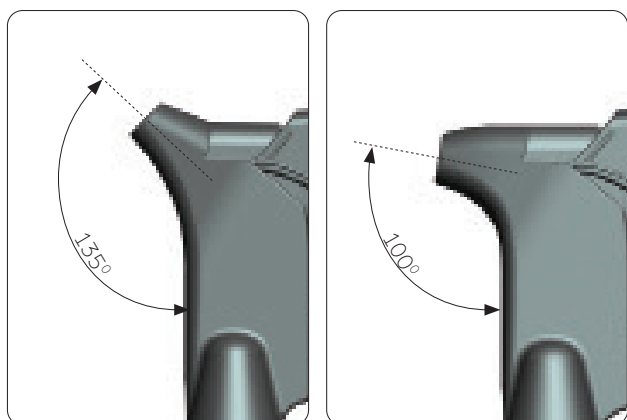

Angled cable outlet

Straight cable outlet

Brake and release handles (double function)



BHRH1 – Brake and release handle (double function) with angled cable outlet

- » Material: PA+GF
- » Textured surface
- » Available for Ø25 mm tube on request

For tube diameter mm	Parking brake function	Quantity of parking brake positions	Type of screw for fitting	Color handle/levers	Part no.
Ø22	Manual	5	Self tapping	Black/Black	671028
Ø25	Manual	5	Self tapping	Black/Black	671058
Ø22	Auto	5	Self tapping	Black/Black	check

Sign up to our newsletter at mbl.dk to stay updated!



Brake handles

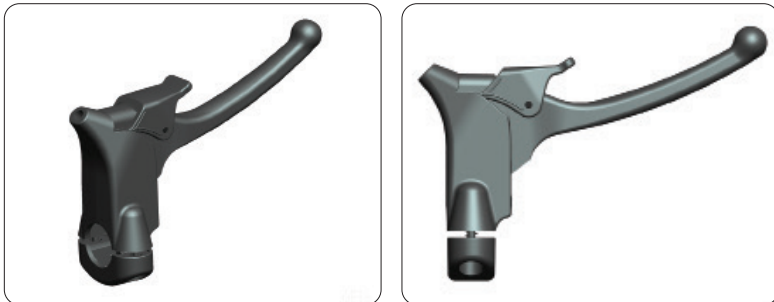

BH1 – Brake handle with angled cable outlet

- » Material: PA+GF
- » Textured surface

For tube diameter mm	Parking brake function	Quantity of parking brake positions	Type of screw for fitting	Color handle/stop lever	Part no.
Ø22	Self-locking	5	Self tapping	Black/Black	671022
Ø22	Manual	5	Self tapping	Black/Black	671032
Ø25	Manual	5	Self tapping	Black/Black	671019

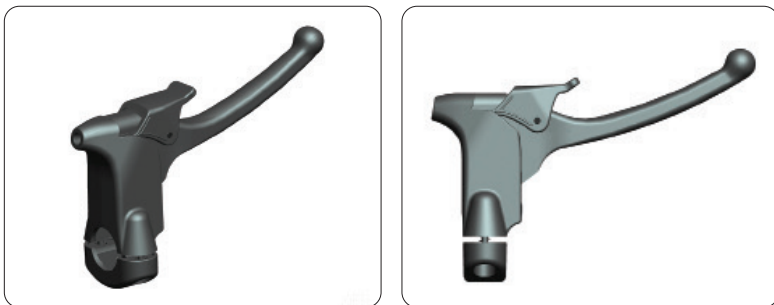

BH1 – Brake handle with straight cable outlet

- » Material: PA+GF
- » Textured surface

For tube diameter mm	Parking brake function	Quantity of parking brake positions	Type of screw for fitting	Color handle/stop lever	Part no.
Ø22	Manual	5	Self tapping	Black/Black	671030

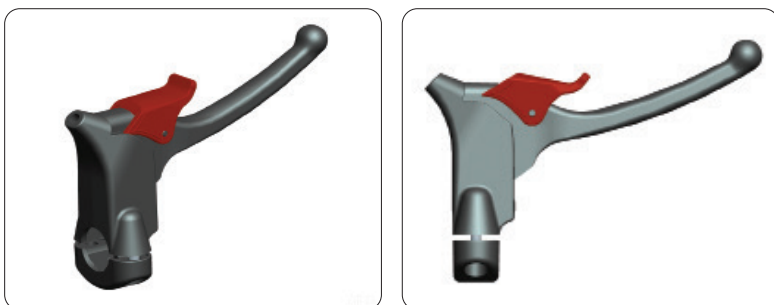

BH2 – Brake handles with angled cable outlet

- » Material: PA+GF
- » Textured surface
- » Version with automatic brake function for Ø25mm tube is available on request

For tube diameter mm	Parking brake function	Quantity of parking brake positions	Type of screw for fitting	Color handle/stop lever	Part no.
Ø22	Manual	5	Normal	Black/Red	671026

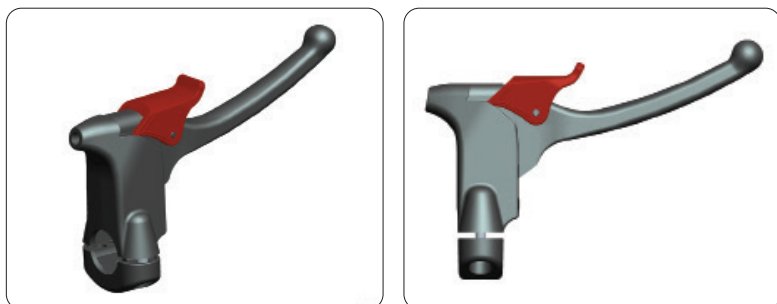

BH2 – Brake handles with straight cable outlet

- » Material: PA+GF
- » Textured surface
- » Version with automatic brake function for Ø25mm tube is available on request

For tube diameter mm	Parking brake function	Quantity of parking brake positions	Type of screw for fitting	Color handle/stop lever	Part no.
Ø22	Self-locking	5	Self tapping	Black/Red	671039

Release handles



RH1 – Release handle

- » Material: PA+GF
- » Textured surface
- » Available for Ø25 mm tube on request

For tube diameter mm	Type of screw for fitting	Color handle/lever	Part no.
Ø22	Self tapping	Black/Black	671034



RH2 – Release handle

- » Material: PA+GF
- » Textured surface
- » Available for Ø25 mm tube on request
- » NB – color of handle is silver – not black as on the illustration!

For tube diameter mm	Type of screw for fitting	Color handle/lever	Part no.
Ø22	Normal	Silver/Red	671044



RH3 - Release handle

- » Material: PA+GF
- » Textured surface
- » Available for Ø25 mm tube on request

For tube diameter mm	Type of screw for fitting	Color handle/lever	Part no.
Ø22	Normal	Black/Blue	67103B

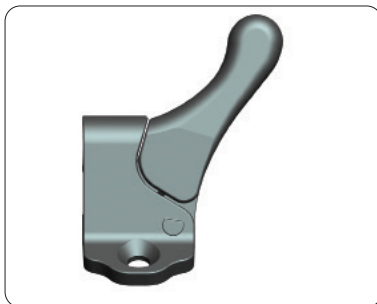

RH5 - Release handle

- » Material handle: PA+GF
- » Material "holder": aluminium
- » Textured surface
- » Recommended for tube diameter Ø22-Ø27mm

For tube diameter mm	Color handle/holder	Part no.
Ø22	Black/Black	671105

**Check our selection
of wheel locks for
active chairs in the
Omobic catalogue.**

