

MBL line Foam parts, supports & textiles



Foam parts, supports & textiles

Foam solutions	5
Customized PU solutions	6
Calf supports	7
Head Support	14
Swing away lateral support	15
Elevating leg support - de luxe	16

Customized textile solutions

Facts about our Textile Department in China

- Since 2005
- 1550 m2 production area
- 100 sewers
- Daily production (dec. 2023):
 - 1200 rollator baskets
 - 1000 backrest
 - 1000 cushions
 - 400 others
- 13.000 m2 of material is processed every month

Why MBL?

- MBL is your one-stop shop
- 20 years of experience in textile production
- Flexible mind-set and production set-up
- Any set up is possible – also small
- Set up costs depends on each model
- Delivery time 45 days on order
- High quality
- We can make all kinds of baskets, cushions, bags, seating systems, belts etc.
- Skilled and motivated Chinese team

Textile examples of what we make

In our sewing department in China we are able to produce all kind of products such as back- and seating systems for wheel chairs, baskets, seats etc. for rollators.

We can help to design the products, provide prototypes/samples and do mass production.

Our modern production lines includes all kind of different sewing methods such as cutting, textile printing, super sonic welding etc.



Please contact our sales department for further information.

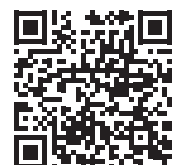

Foam solutions

Cut foam

Cut foam can be made into any regular shape. We recommend this for users that do not need to stay in their chair for a long time or use their chair so frequently.

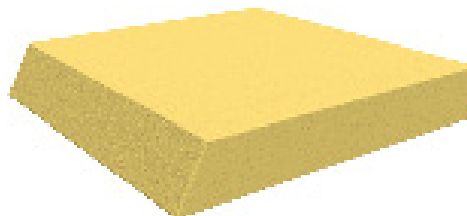

Molded foam

Moulded foam can be made into any shape in order to support where needed. When the pressure is well distributed, the comfort is improved for the user.

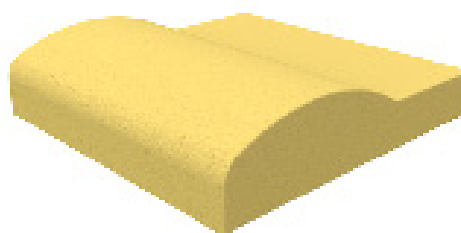

Cushion with wooden plate

The wooden plate release spine pressure and gives a more stable support to the body.

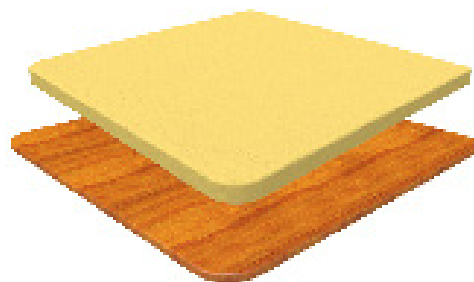

Multi-layered cushion

The bottom layer and the side support is made out of high-density sponge. A special fabric layer gives extra support. The front layer is made of medium density sponge and the rear layer is made of low-density sponge. The pommel support is made of medium density sponge. The upper layer is made out of sliced low density sponge.

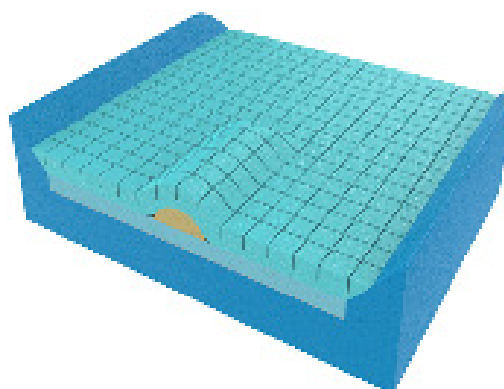

Customized PU solutions

Our PU production line

In our modern PU production department we are able to produce almost all kinds of Polyurethane Products such as:

- Head supports
- Arm supports
- Calf supports
- Amputee support

And much more

Customized PU Solutions

The larger part of the PU products we make are designed together with our customers who need specific solutions that fit their wheelchair, rollator or other product.

Materials – Environment and health

We only use environmental friendly PU raw material which does not contain any harmful components such as HCFC or others according to Montreal Protocol of 2004.

Would you like to know more?

Please do not hesitate to contact MBL sales department should you have any questions.

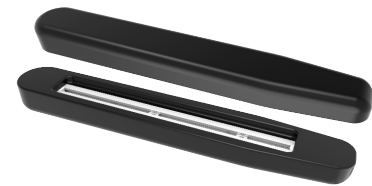

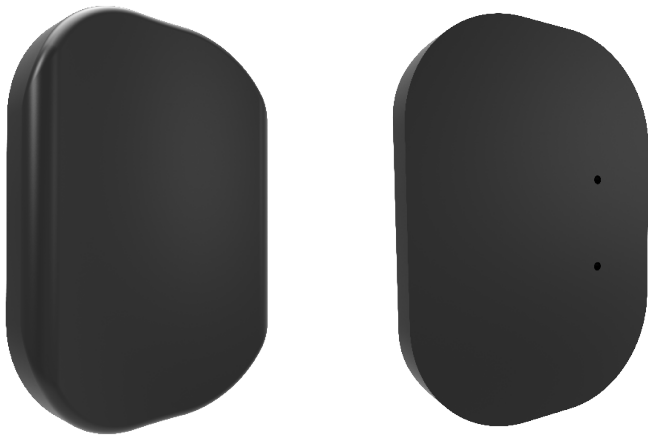

Calf supports

Type A

- » Water-based soft and comfortable self-skinning PU foam
- » Water resistant
- » Bio compatible & environment friendly
- » Good abrasive performance
- » Fixation: please see drawing

Widht mm	Height mm	Depth mm	Part no.
150	210	22-30	MI0122

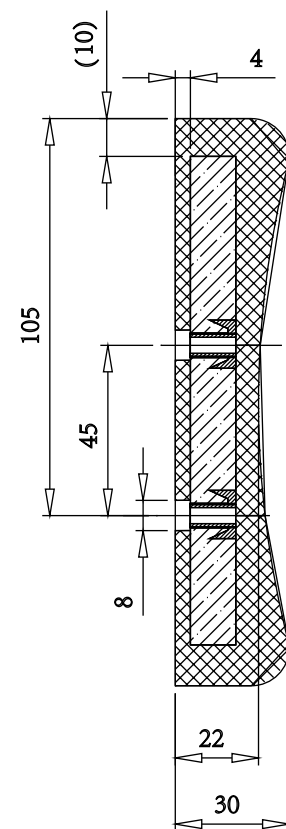
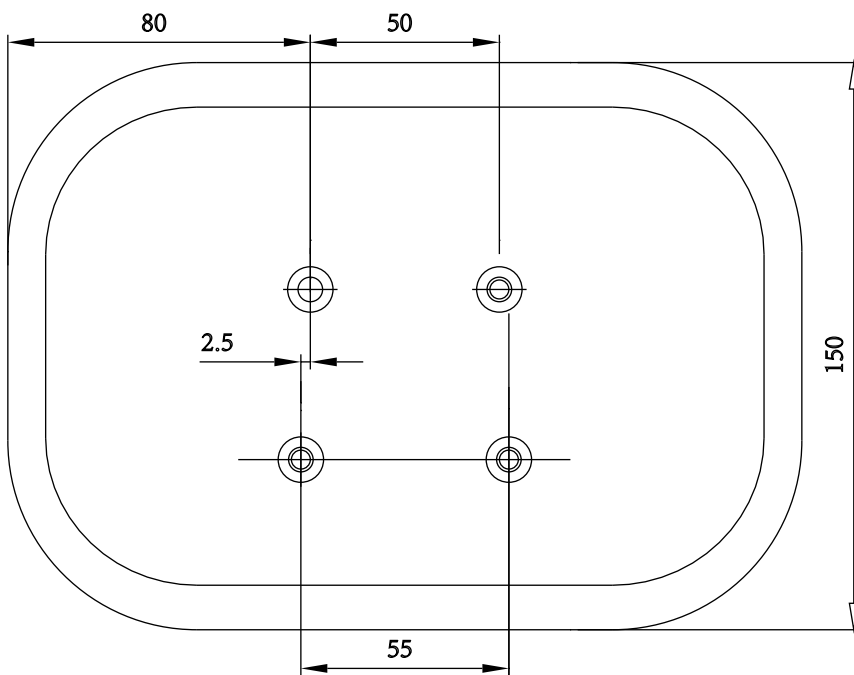
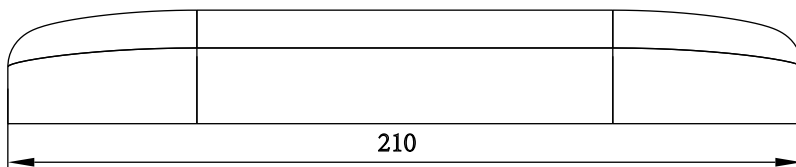



Type B

- » Water-based soft and comfortable self-skinning PU foam
- » Water resistant
- » Bio compatible & environment friendly
- » Good abrasive performance
- » Fixation: please see drawing

Widht mm	Height mm	Depth mm	Part no.
120	147	21-29	712530

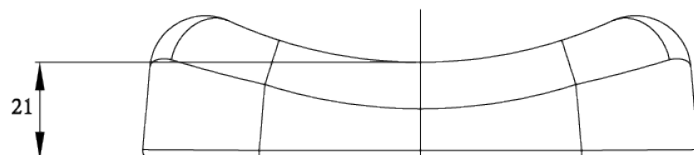
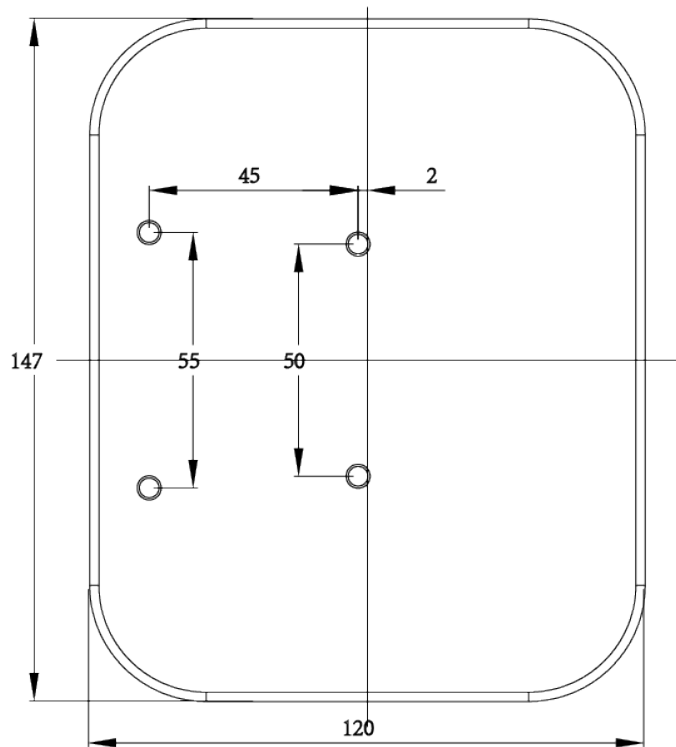
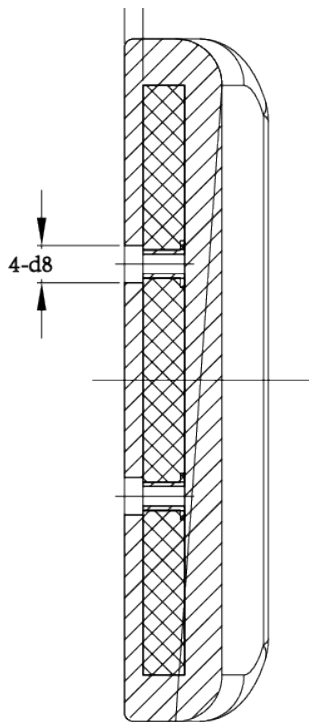

Arm supports

Type A

» Adjustable with sliding fitting holes



Dist. fixation holes mm	Lenght mm	Total Height mm	Width mm	Part no.
Can be adjusted	235	26,6	50,5	761004

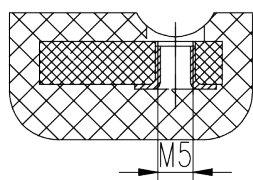
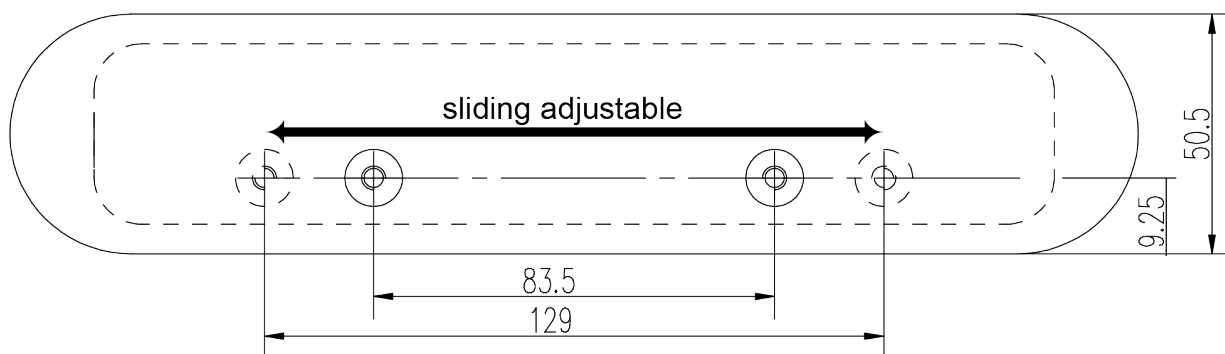
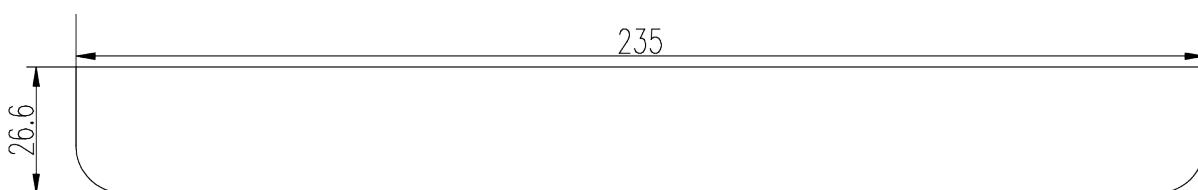

1



Type C

- » PU arm pad with bended
- » front-end for placing hand in an ergonomically friendly way
- » L=227mm, with 2 holes for fixation
- » Please see drawing for fixation details

Dist. fixation holes mm	Length mm	Total height mm	Thickness mm	Width mm	Part no.
120	227	227	22	49,5	7211NN

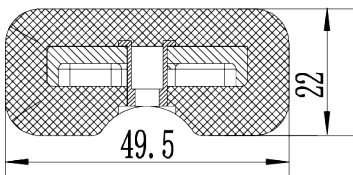
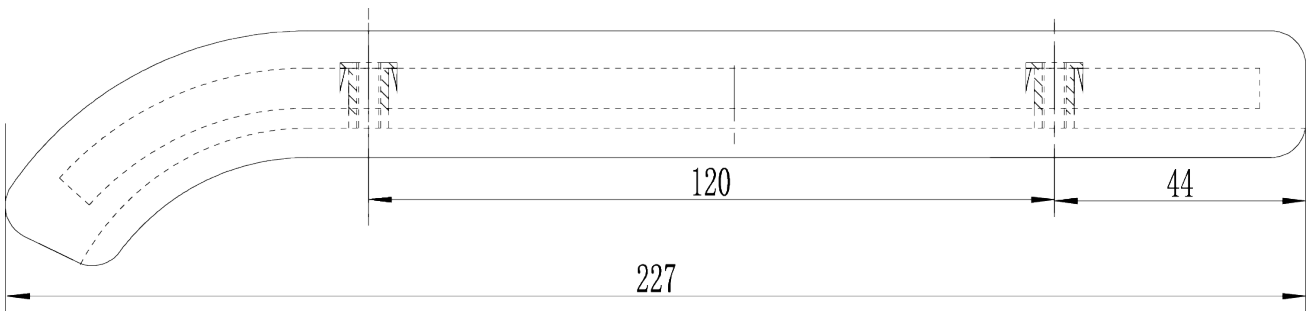



Type D

- » PU arm pad with bended
- » front-end for placing hand in an ergonomically friendly way
- » L= 364 mm, with 2 holes for fixation
- » Please see drawing for fixation details

Dist. fixation holes mm	Length mm	Total Height mm	Thickness mm	Width mm	Part no.
?	364	47	30	52,5	76100E

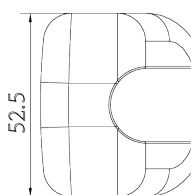
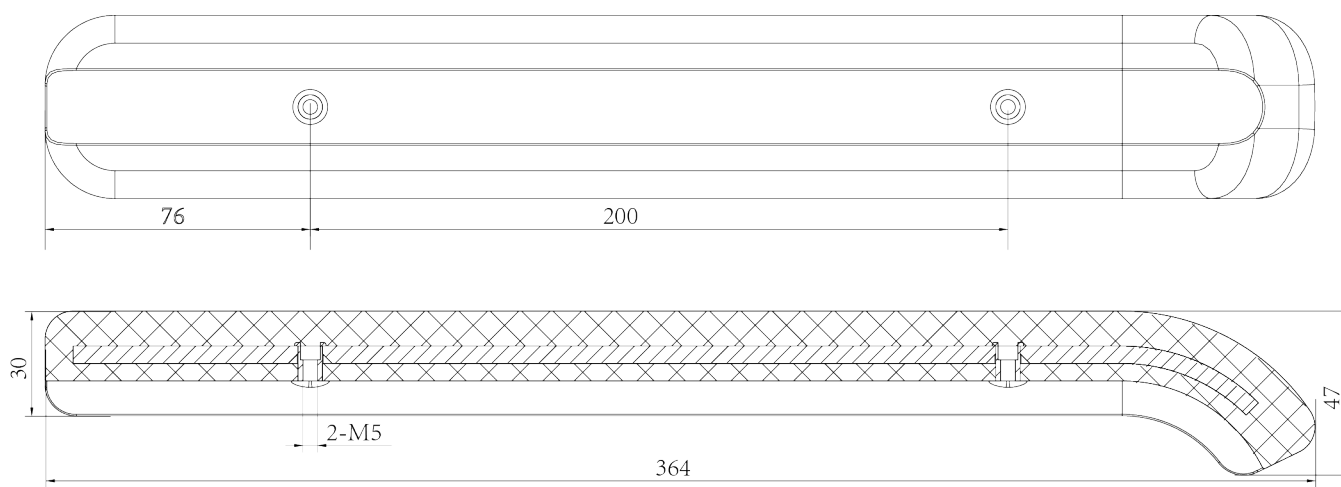



Type E

- » PU arm support,
- » L=304mm,with steel plate insert
- » 6 holes for height adjustment

Dist. fixation holes mm	Lenght mm	Total Height mm	Thickness mm	Width mm	Part no.
?	304	?		61	MI110B

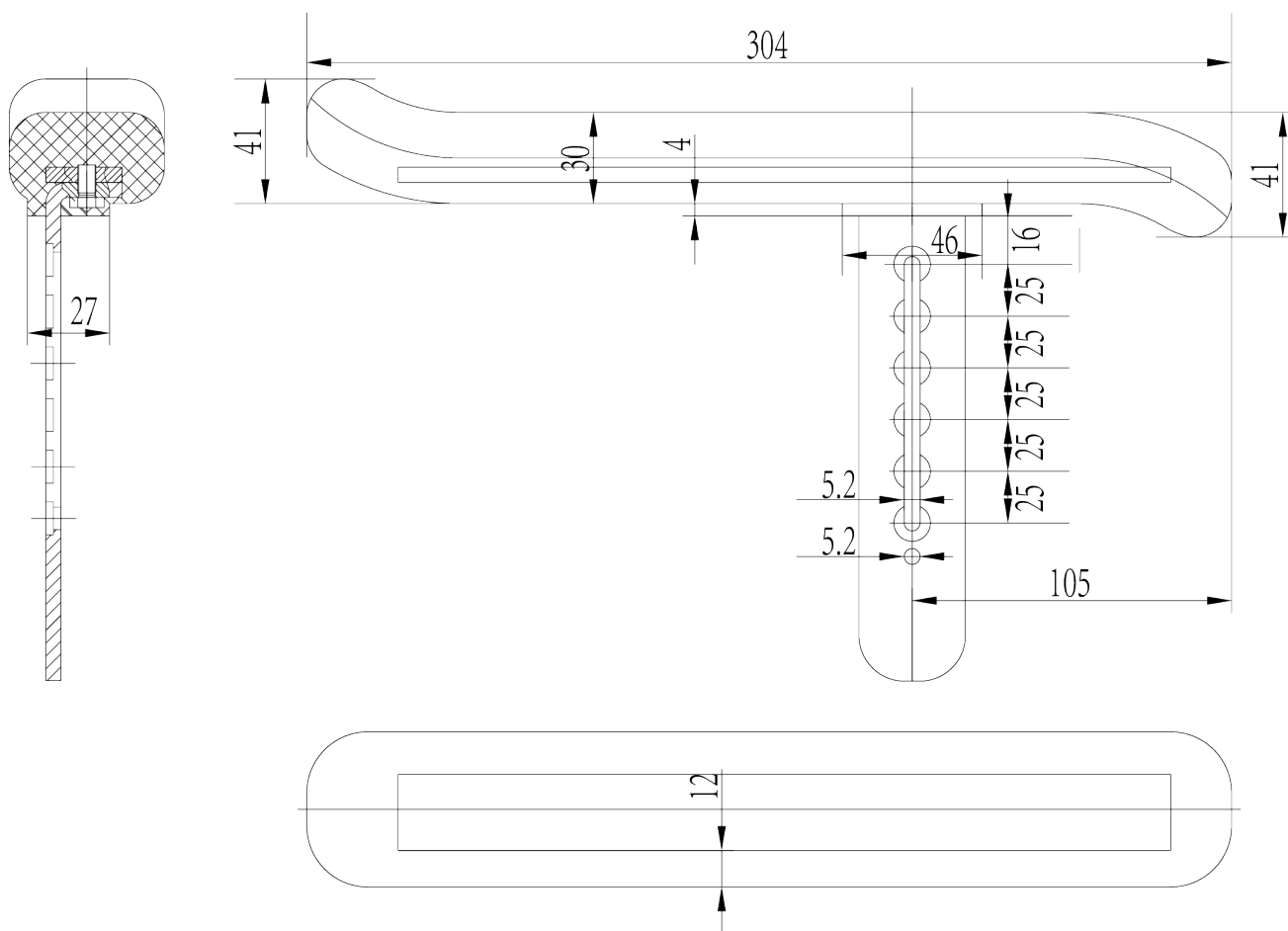

Carbon solutions for rehab industry

**Skilfully engineered. Delivered fast.
Quality you can trust.**



View the video about
our carbon competencies



Head Support

Type B

- » PU head support pad with steel insert
- » 2 holes for fixation



Width mm	Height mm	Depth mm	Part no.
245	158	104	00000M

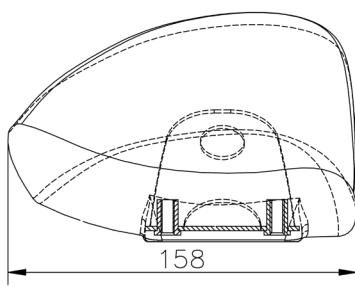
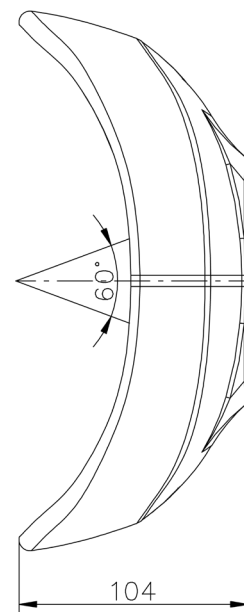
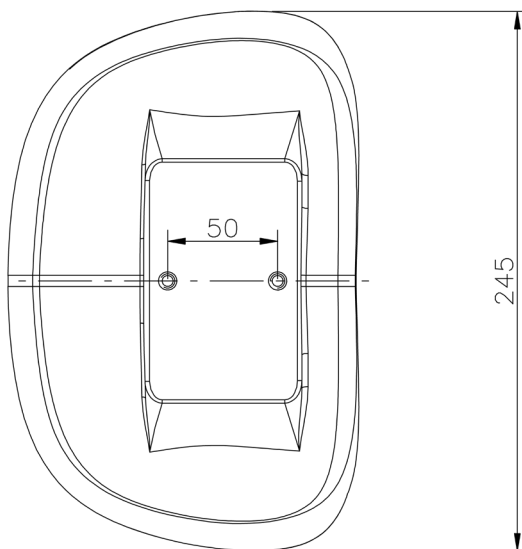



Swing away lateral support

Type B (short version)

Description	Part no. LEFT side	Part no. RIGHT side
Lateral support with PU pad, short version	9311ML	9311MR

Sign up to our
newsletter at
mbl.dk to stay
updated!



Elevating leg support – de luxe



The MBL leg support provides an excellent support for the wheelchair user.

With the two patented mechanisms for angle adjustment and calf supports it is a unique accessory for all users who requires an elevating leg support.

Features

- » Easy adjustable in angle.
- » 7 step angle positions (self locking). Patented system.
- » The entire leg support can swing out.
- » 4 different positions of the calf pad
- » Calf pad can swing backwards for easy transfer in and out of the chair.
- » The footrest and the calf support are height adjustable with out any use of tools.
- » The calf pad can freely adapt to the required angle
- » Available with depth adjustable footrests.
- » The footrest can be adjusted in angle by means of our toothed hinge system.
- » Can be adapted to any kind of wheel chairs.
- » Fits all common seat widths and seat heights.

Footrest width mm	Part no. LEFT SIDE	Part no. RIGHT SIDE
160	9311BL2	9311BR2
170	9311BL3	9311BR3
185	9311BL4	9311BR4
200	9311BL5	9311BR5

Would you like to see and learn more?

MBL website



Our videos on YouTube



Check our Facebook



Connect with us on LinkedIn



Connect with us on WeChat



Other product categories:

Front wheels 4"-8"



Rear wheels 12"-26"



Tyres, PU tyres, tubes , infills & tyres
w insert for manual wheelchairs 6"-26"



Pushrims & pushrim covers



Front forks & bearing housings



QR axles and bushings



Hand brakes, brake handles & release handles



Other wheelchair components & accessories



Tyres, tubes and tyres with infills
for power wheelchairs



MBL Denmark

MBL a/s

Glarmestervej 18 B, St. Th.

8600 Silkeborg

CVR: 12825242

contact@mbl.dk

MBL Poland

MBL Poland Sp. z o.o.

Sulejowska 45d

97-300 Piotrkow Trybunalski

VAT No: 7710008003

Tel: +48 44 73 24 100

contact@mbl.pl

MBL China

MBL (Xiamen) Co. Ltd.

No.289 Wengjiao Road Xinyang

Industrial District Haicang

361022 Xiamen

Tel: +86 592 5961 896

contact@mbl.com.cn

March 2026